



**Institut de
Tecnologia de la Construcció
de Catalunya**

Wellington 19
ES08018 Barcelona
T +34 933 09 34 04
qualprod@itec.cat
itec.cat



Member of



www.eota.eu

European Technical Assessment

ETA 17/0355
of 04.09.2019



General part

Technical Assessment Body issuing the ETA: ITeC	
ITeC has been designated according to Article 29 of Regulation (EU) No 305/2011 and is member of EOTA (European Organisation for Technical Assessment)	
Trade name of the construction product	Faveton® SAH
Product family to which the construction product belongs	9 - Kits for external wall claddings.
Manufacturer	FAVETON TERRACOTA, S.L. Herrera de los Navarros km 1,5 ES-50450 Muel (Zaragoza) Spain
Manufacturing plant(s)	Herrera de los Navarros km 1,5 ES-50450 Muel (Zaragoza) Spain
This European Technical Assessment contains	25 pages including 3 annexes which form an integral part of this assessment.
This European Technical Assessment is issued in accordance with Regulation (EU) 305/2011, on the basis of	EAD 090062-00-0404 <i>Kits for external wall claddings mechanically fixed.</i>
This ETA replaces	ETA 17/0355 issued on 30.05.2017.

General comments

Translations of this European Technical Assessment in other languages shall fully correspond to the original issued document and should be identified as such.

Communication of this European Technical Assessment, including transmission by electronic means, shall be in full. However, partial reproduction may be made, with the written consent of issuing Technical Assessment Body. Any partial reproduction has to be identified as such.

Specific parts of the European Technical Assessment

1 Technical description of the product

This ETA refers to Faveton® SAH kits¹ for external wall cladding in ventilated façades.

Faveton® SAH kits components are given in table 1.1.

Detailed information and data of all the components are given in the annexes of this ETA.

Fixings between brackets and substrate are not part of the kit assessed in this ETA.

Table 1.1: Kits components.

N.	Generic component	Faveton® SAH kits (family C)				Technical description in Annex 1
		Faveton® Ceram 20	Faveton® Ceram 28	Faveton® Acqua 20-H	Faveton® Acqua 20-V	
1	Cladding element (*)					A1.1
2	Cladding fixing	Fixing device	Stainless steel clips			A1.2
		Screw	Stainless steel screws			A1.3
3	Subframe	Vertical profile	Aluminium alloy T profiles			A1.3
		Bracket	Aluminium alloy brackets			
		Subframe fixings	Between clips and vertical profiles			
		Ancillary components	EPDM joint profile			

(*) Extruded ceramic tiles according to EN 14411.

2 Specification of the intended use(s) in accordance with the applicable European Assessment Document (hereinafter EAD)

Faveton® SAH kit is intended to be used as external wall claddings in ventilated façades (rainscreens). The walls are made of masonry (clay, concrete or stone), concrete (cast on site or as prefabricated panels), timber or metal frame in new or existing buildings (retrofit).

The characteristics of the walls shall be verified prior to use of Faveton® SAH kit, especially regarding conditions for reaction to fire classification and for mechanical fixing of Faveton® SAH kit.

The provisions made in this European Technical Assessment are based on an assumed working life of at least 25 years for Faveton® SAH kit. The indications given on the working life cannot be interpreted as a guarantee given by the producer, but are to be regarded only as a means for choosing the right products in relation to the expected economically reasonable working life of the works.

Faveton® SAH kit is made of non-load bearing construction components. They do not contribute directly to the stability of the wall on which they are installed, but they can contribute to its durability by providing enhanced protection from the effect of weathering.

Faveton® SAH kit is not intended to ensure the airtightness of the building envelope.

Detailed information and data regarding design, installation, maintenance and repair criteria are given in Annexes 2 and 3.

¹ "Kit" means a construction product placed on the market by a single manufacturer as a set of at least two separate components that need to be put together to be incorporated in the construction works (Art. 2 n° 2 CPR).

3 Performance of the product and reference to the methods used for its assessment

The assessment of FAVEKER® FV kit for the intended use was performed following EAD 090062-00-0404 *Kits for external wall claddings mechanically fixed*.

Table 3.1: Summary of the Faveton® SAH kit performances (see also detailed performance in relevant sections).

Product: Faveton® SAH kit		Intended use: External wall claddings in ventilated façades (rainscreens).			
Basic Works Requirement	ETA section	Essential characteristic	Performance		
BWR 2 Safety in case of fire	3.1	Reaction to fire	B-s1, d0		
	---	Façade fire performance	Not assessed		
	---	Propensity to undergo continuous smouldering	Not relevant (the thermal insulation is not a kit component)		
BWR 3 Hygiene, health and the environment	3.2	Watertightness of joints (protection against driving rain)	Not watertight (open joints)		
	---	Water absorption	Not relevant		
	---	Water vapour permeability	Not relevant		
	3.3	Drainability	See figures in Annex 2		
	---	Content and/or release of dangerous substances	Not assessed		
BWR 4 Safety and accessibility in use	3.4	Wind load resistance	Faveton® Ceram 20	2800 Pa	
			Faveton® Ceram 28		
			Faveton® Acqua 20-H		3400 Pa
			Faveton® Acqua 20-V		3600 Pa
	---	Resistance to horizontal point loads	Not assessed		
	3.5	Impact resistance	See table 3.3		
	3.6	Bending strength of cladding element	≥ 14 MPa		
	3.7	Resistance of grooved cladding elements	≥ 232 N		
	3.8	Resistance to vertical load	< 0,1 mm after 1h		
	3.9	Pull-through resistance of fixings from profile	≥ 7,2 kN		
	3.10	Resistance of metal clip	≥ 500 N		
	3.11	Resistance of profiles	See section 3.11		
	3.12	Tension / Pull-out resistance of subframe fixings	≥ 0,45 kN		
	3.13	Shear load of subframe fixings	≥ 1,7 kN		
3.14	Bracket resistance (horizontal and vertical load)	See tables 3.8			
BWR 5 Protection against noise	---	Airborne sound insulation	Not relevant		
BWR 6 Energy economy and heat retention	---	Thermal resistance of the kit	Not relevant (use in ventilated façades and the thermal insulation is not a kit component)		
	---	Thermal resistance of thermal insulation product			
Durability aspects	---	Hygrothermal behaviour	Not relevant		
	3.15	Behaviour after pulsating load	Metal clip resistance ratio 94%		
	3.16	Freeze-thaw resistance	No defects		
	---	Behaviour after immersion in water	Not relevant		
	3.17	Dimensional stability of the cladding elements	by temperature	≤ 5,1 µm/(m·°C)	
			by humidity	≤ 0,2 mm/m	
---	Chemical and biological resistance	Not relevant			

Table 3.1: Summary of the Faveton® SAH kit performances (see also detailed performance in relevant sections).

Product:	Faveton® SAH kit	Intended use:	External wall claddings in ventilated façades (rainscreens).
Basic Works Requirement	ETA section	Essential characteristic	Performance
	---	UV radiation resistance	Not relevant
	3.18	Corrosion	See section 3.18

Complementary information:

Requirements with respect to the mechanical resistance and stability of non-load bearing parts of the works are not included in the Basic Works Requirement Mechanical resistance and stability (BWR 1) but are treated under the Basic Works Requirement Safety and accessibility in use (BWR 4).

The fire resistance requirement is applicable to the wall (made of masonry, concrete, timber or metal frame) and not to the Faveton® SAH kit itself.

3.1 Reaction to fire

Reaction to fire of Faveton® SAH kit according to Commission Delegated Regulation (EU) 2016/364 and EN 13501-1 is class B-s1,d0. It is based on the relevant tests according to EN 13501-1 including EPDM joint profiles.

These classes are valid provided that the insulation layer placed behind the cladding elements is made of non-combustible materials (e.g. mineral wool) or that the layer behind the cladding elements is a mineral substrate like masonry or concrete (class A1 or A2-s1, d0). For other end use conditions (for example: with insulation layer made of EPS, XPS, PUR or PF), the reaction to fire of the external wall claddings for ventilated façades will be the reaction to fire of the insulation material.

Note: A European reference fire scenario has not been laid down for façades. In some Member States, the classification of external wall claddings according to EN 13501-1 might not be sufficient for the use in façades. An additional assessment of external wall claddings according to national provisions (e.g. on the basis of a large-scale test) might be necessary to comply with Member State regulations, until the existing European classification system has been completed.

3.2 Watertightness of joints (protection against driving rain)

Joints between the cladding elements in the external wall claddings for ventilated façades are open, therefore the Faveton® SAH kit are not watertight.

3.3 Drainability

On the basis of the construction details (see Annex 2), the available technical knowledge, experience and the installation criteria, it is considered that the water which penetrates into the air space or the condensation water can be drained out from the cladding without accumulation or moisture damage or leakage into the substrate.

3.4 Wind load resistance

Wind load resistance has been determined considering the wind suction resistance tests and the mechanical resistance of components (see sections 3.6 to 3.14). Different cases have been tested depending on the cladding element.

The worst cases have been tested: minimum bending strength, minimum thickness, minimum density of cladding fixings (four clips for each cladding element) and the maximum span between vertical profiles. Test results are given in table 3.2.

For other assembled systems, wind load resistance obtained by calculation on the basis of the mechanical resistance of the kit components should not be higher than the maximum load obtained in the tests.

Table 3.2: Wind load resistance tests.

Test	Cladding element	Cladding fixing	Maximum load Q (Pa)	Displacement under maximum load (mm) [deflection after 1 min recovery]
Suction (1)	Faveton® Ceram 20	Clips	2800 (4)	14,40 (5) [7,64 mm]
Suction (2)	Faveton® Acqua 20-H	Clips	3400 (4)	13,21 (6) [3,06 mm]
Suction (3)	Faveton® Acqua 20-V	Clips	3600 (4)	14,17 (7) [2,30 mm]

(1) Tests specimen: four tiles 1000 mm x 500 mm (L x H) and eight tiles 700 mm x 500 mm (L x H) with four clips for each panel, four vertical profiles (2 T-profiles and 2 L-profiles) at a maximum distance of 1000 mm, EPDM profiles, brackets wing length 60 mm or 90 mm, maximum distance between brackets of 750 mm, and subframe fixings.

(2) Tests specimen: two tiles 1000 mm x 600 mm (L x H), two tiles 1000 mm x 400 mm (L x H), four tiles 700 mm x 600 mm (L x H) and four tiles 700 mm x 400 mm (L x H) with four clips for each panel, four vertical profiles (2 T-profiles and 2 L-profiles) at a maximum distance of 1000 mm, EPDM profiles, brackets wing length 60 mm or 90 mm, maximum distance between brackets of 750 mm, and subframe fixings.

(3) Tests specimen: four tiles 600 mm x 1200 mm (L x H) and eight tiles 600 mm x 400 mm (L x H) with four clips for each panel, four vertical profiles (2 T-profiles and 2 L-profiles) at a maximum distance of 1000 mm, EPDM profiles, brackets wing length 60 mm or 90 mm, maximum distance between brackets of 750 mm, and subframe fixings.

(4) Maximum load reached without kit failure.

(5) Displacement measured at the corner on the central 1000 mm x 500 mm tile.

(6) Displacement measured at the horizontal central edge on the central 1000 mm x 600 mm tile.

(7) Displacement measured at the vertical central edge on the central 600 mm x 1200 mm tile.

3.5 Impact resistance

Impact resistance has been tested in the assembled systems given in table 3.3.

For other assembled systems or other cladding elements different than those given in the table 3.3, the impact resistance has not been assessed.

Table 3.3: Impact resistance.

Trade name	Cladding element		Cladding fixing	Impact resistance passed	Degree of exposure in use (*)
	Length, L (mm)	High, H (mm)	Num. clips		
Faveton® Ceram 20	≥ 500	≤ 500	4	H1: Hard body (0,5 kg) 3 impacts of 1 J S1: Soft body (3,0 kg) 3 impacts of 10 J	Category IV
Faveton® Ceram 28					
Faveton® Acqua 20-H	≥ 400	≤ 600		H1: Hard body (0,5 kg) 3 impacts of 1 J S1: Soft body (3,0 kg) 3 impacts of 10 J	Category IV
Faveton® Acqua 20-V	600	≥ 400	4	H1: Hard body (0,5 kg) 3 impacts of 1 J S1: Soft body (3,0 kg) 3 impacts of 10 J	Category IV
	600	≥ 800	4	H1: Hard body (0,5 kg) 3 impacts of 1 J H2: Hard body (0,5 kg) 3 impacts of 3 J S1: Soft body (3,0 kg) 3 impacts of 10 J	Category III

Table 3.3: Impact resistance.

Trade name	Length, L (mm)	High, H (mm)	Cladding fixing Num. clips	Impact resistance passed	Degree of exposure in use (*)
(*) Category I: This category means that the degree of exposure in use should be a zone readily accessible to the public at ground level and vulnerable to hard body impacts but not subjected to abnormally rough use.					
Category II: This category means that the degree of exposure in use should be a zone liable to impacts from thrown or kicked objects, but in public locations where the height of the kit will limit the size of the impact; or at lower levels where access to the building is primarily to those with some incentive to exercise care.					
Category III: This category means that the degree of exposure in use should be a zone not likely to be damaged by normal impacts caused by people or by thrown or kicked objects.					
Category IV: This category means that the degree of exposure in use should be a zone out of reach from ground level.					

3.6 Bending strength of the cladding element

Bending strength of the cladding element has been tested according to EN 10545-4.

Mean values of the breaking load, breaking strength and bending strength are given in table 3.4.

Table 3.4: Bending strength of the cladding element.

Specimen	Breaking load (N)		Breaking strength (N)		Bending strength (MPa)	
	F _m	F _c	F _m	F _c	F _m	F _c
Faveton® Ceram 20 (*)	696	589	3165	2687	14,0	11,6
Faveton® Ceram 28 (*)	4413	4149	8164	7675	15,6	14,7
Faveton® Acqua 20 (*)	1036	869	4921	4126	19,9	16,7
Faveton® Acqua 20 (**)	1047	946	6019	5440	22,4	20,1

Where: F_m = mean values; F_c = characteristic values giving 75% confidence that 95% of results will be higher than this value.

(*) Test supports parallel to the piece holes.

(**) Test supports parallel to the piece holes.

3.7 Resistance of grooved cladding elements

Mean and characteristic values of the grooved cladding elements are given in table 3.5.

The worst cases have been tested.

Table 3.5: Resistance of grooved cladding elements.

Specimen	Resistance (N)					
	Top groove		Lower groove		Cut groove	
	F _m	F _c	F _m	F _c	F _m	F _c
Faveton® Ceram 20	1046	943	1055	885	385	232
Faveton® Ceram 28	1280	1132	1079	869	717	577
Faveton® Acqua 20	1674	1448	(*)	(*)	608	502
Faveton® Acqua 20-V (**)	810	763	(*)	(*)	---	---

(*) For Faveton® Acqua 20, top and lower grooves are identical (see figures in Annex 1).

(**) In vertical cladding element position the clip is introduced in the hole.

Where: F_m = mean values; F_c = characteristic values giving 75% confidence that 95% of results will be higher than this value.

3.8 Resistance to vertical load of cladding fixing

The deflection of the cladding fixings has been less than 0,11 mm after 1 hour. A vertical load of 518 N has been applied. The worst case has been tested: tile with maximum weight (Faveton® Ceram 28), distance between clips 1000 mm.

3.9 Pull-through resistance of fixings from profile

Pull-through resistance of fixings on vertical profile has been tested. Mean and characteristic values of the pull-through resistance are given in table 3.6.

Table 3.6: Pull-through resistance of fixing from vertical profile.

Specifications	Failure load (N)		Failure mode
	F _m	F _c	
Profile: Thickness 1,8 mm, AW-6063 aluminium alloy. Self-drilling screw: Ø5,5 mm, A2 stainless steel.	8529	7286	Screw came out

Where: F_m = mean values; F_c = characteristic values giving 75% confidence that 95% of results will be higher than this value.

3.10 Resistance of metal clips

Resistance of metal clips has been tested. Mean and characteristic values are given in table 3.7.

Worst cases have been tested.

Table 3.7: Resistance of metal clip.

Type of load	Clip type	Resistance (N) at 1 mm of permanent deflection		Ultimate resistance (N)			Failure
		F _m	F _c	F _m	F _c	Ratio	
Horizontal load	CF-41,5xDx11	952	886	1768	1734	---	Clip deflection
	CF-41,5xDx5	558	499	1097	1058	---	
Behaviour after pulsating horizontal load	CF-41,5xDx11	---	---	1660	1629	94%	
	CF-41,5xDx5	---	---	NPA	NPA	---	
Vertical load	CF-41,5xDx11	471	447	532	514	---	
	CF-41,5xDx5	322	304	596	555	---	

Where: F_m = mean values; F_c = characteristic values giving 75% confidence that 95% of results will be higher than this value.
NPA = Not assessed.

3.11 Resistance of profiles

The following characteristics of the vertical profiles are given in Annex 1:

- Form and dimensions of the profiles' sections.
- Inertia of the profiles' sections.
- Minimum elastic limit of the profiles' material.

3.12 Tension / Pull-out resistance of subframe fixings

Minimum value of pull-out resistance of the self-drilling stainless steel screw (Ø5,5 mm) on aluminium alloy profile (1,8 mm) is 0,45 kN.

3.13 Shear load resistance of subframe fixings

Minimum value of shear load resistance of the self-drilling stainless steel screw ($\varnothing 5,5$ mm) on aluminium alloy profile (1,8 mm) is 1,70 kN.

3.14 Bracket resistance (vertical and horizontal load)

Bracket resistance to horizontal load has been tested (see table 3.8a). Bracket resistance to vertical load has been tested (see table 3.8b).

The worst cases have been tested.

Table 3.8a: Bracket resistance to horizontal load.

Bracket H x L x B x t (mm)	Resistance (N) at 1 mm of displacement		Ultimate resistance (N)	
	F _m	F _c	F _m	F _c
CAA_120 x 60 x 60 x 3,0				
CAA_120 x 90 x 60 x 3,0 (*)	2782	2298	6380	6120
CAA_120 x 90 x 60 x 3,0 (r) (*)	1017	902	2025	1840
CAA_120 x 90 x 60 x 4,0 (*)	4859	4473	11060	10432
CAA_120 x 90 x 60 x 4,0 (r) (*)	2188	1929	3907	3445
CAA_120 x 100 x 60 x 3,0				
CAA_120 x 120 x 60 x 3,0	2637	1984	7737	7167
CAA_120 x 140 x 60 x 3,0 (*)				
CAA_60 x 60 x 60 x 3,0				
CAA_60 x 90 x 60 x 3,0 (*)	2783	1950	4434	3572
CAA_60 x 90 x 60 x 3,0 (r) (*)	512	322	1077	988
CAA_60 x 90 x 60 x 4,0 (*)	3908	3296	6528	6196
CAA_60 x 90 x 60 x 4,0 (r) (*)	641	294	1839	1746
CAA_60 x 100 x 60 x 3,0				
CAA_60 x 120 x 60 x 3,0	1994	1721	3831	3306
CAA_60 x 140 x 60 x 3,0 (*)				

Where:

L = length; H = height; B = base; t = thickness

F_m = mean values; F_c = characteristic values giving 75% confidence that 95% of results will be higher than this value.

(*) Tested bracket.

(r) = It indicates that the bracket may be opposite positioned, i.e. the base is the wing.

Table 3.8b: Bracket resistance to vertical load.

Bracket H x L x B x t (mm)	Resistance (N) at 1 mm of displacement		Resistance (N) at 3 mm of displacement		Resistance at $\Delta L = 0,2\% \cdot L$ mm of permanent deflection (N)		Ultimate resistance (N)	
	F _m	F _c	F _m	F _c	F _m	F _c	F _m	F _c
CAA_120 x 60 x 60 x 3,0								
CAA_120 x 90 x 60 x 3,0 (*)	1091	339	1600	609	2918	1990	5946	4781
CAA_120 x 90 x 60 x 3,0 (r) (*)	546	279	1277	989	2529	1975	5913	5417
CAA_120 x 90 x 60 x 4,0 (*)	1174	742	2000	1425	5021	4325	9543	8631
CAA_120 x 90 x 60 x 4,0 (r) (*)	664	577	1614	1240	3296	2397	7788	6790

Table 3.8b: Bracket resistance to vertical load.

Bracket H x L x B x t (mm)	Resistance (N) at 1 mm of displacement		Resistance (N) at 3 mm of displacement		Resistance at $\Delta L = 0,2\% \cdot L$ mm of permanent deflection (N)		Ultimate resistance (N)	
	F _m	F _c	F _m	F _c	F _m	F _c	F _m	F _c
CAA_120 x 100 x 60 x 3,0	1004	762	1236	898	2346	1194	4417	2524
CAA_120 x 120 x 60 x 3,0 (*)								
CAA_120 x 140 x 60 x 3,0 (*)	766	590	957	764	1822	1398	3372	3094

Where:

H = height; L = length; B = base; t = thickness

F_m = mean values; F_c = characteristic values giving 75% confidence that 95% of results will be higher than this value.

(*) Tested bracket.

(r) = It indicates that the bracket may be opposite positioned, i.e. the base is the wing.

3.15 Resistance after pulsating load

Resistance of metal clip after pulsating load has been tested. Results are given in table 3.7.

3.16 Freeze-thaw resistance

Freeze-thaw resistance has been tested according to EN ISO 10545-12 with no defects.

3.17 Dimensional stability of the cladding elements

Moisture expansion and linear thermal expansion of the cladding elements has been tested according to EN ISO 10545-10 and EN ISO 10545-8 respectively.

The maximum moisture expansion of Faveton® tiles is 0,20 mm/m.

The maximum linear thermal expansion of Faveton® tiles is 5,1 $\mu\text{m}/(\text{m} \cdot ^\circ\text{C})$.

3.18 Corrosion of metal components

The cladding fixings (clips) are made of stainless steel 1.4016 according to EN 10088 and the subframe fixings are made of A2 stainless steel according to EN ISO 3506-1. Therefore, these components may be used in dry internal conditions or exposure in permanent damp internal conditions and also in external atmospheric exposure with high category of corrosivity of the atmosphere (included industrial and marine environment, C4 as defined in ISO 9223), provided that no particular aggressive conditions exist. Such particular aggressive conditions are e.g. permanent or alternating immersion in seawater or the splash zone of seawater, chloride atmosphere of indoor swimming pools or atmosphere with extreme chemical pollution (e.g. in desulphurization plants or road tunnels where de-icing materials are used).

The vertical profiles are made of aluminium alloy AW-6063 and brackets are made of aluminium alloy AW-6060 according to EN 573, EN 1999 and EN 755. The durability is class B and the minimum thickness is 1,8 mm. Therefore, these components may be used in the following external atmospheric exposure: rural environment, moderate industrial/urban environment, but excluding industrial marine environment. These components may be used in other external atmospheric conditions exposure if the components are protected as indicated in EN 1999-1-1.

4 Assessment and verification of constancy of performance (hereinafter AVCP) system applied, with reference to its legal base

According to the decision 2003/640/EC, as amended of the European Commission², the systems of AVCP (see EC delegated regulation (EU) No 568/2014 amending Annex V to Regulation (EU) 305/2011) given in the following table apply.

Table 4.1: Applicable AVPC system.

Product	Intended use	Level or class	System
Exterior wall claddings	External finishes of walls	Any	2+
	For uses subject to regulations on reaction to fire	B-s1, d0 (**)	3

(**) Class B,s1-d0 for Faveton[®] SAH kit which contains the EPDM joints.

5 Technical details necessary for the implementation of the AVCP system, as foreseen in the applicable EAD

All the necessary technical details for the implementation of the AVCP system are laid down in the *Control Plan* deposited with the ITeC³, with which the factory production control shall be in accordance.

Issued in Barcelona on 4 September 2019

by the Catalonia Institute of Construction Technology.



Ferran Bermejo Nualart
 Technical Director, ITeC

² 2003/640/EC – Commission Decision of date 4 September 2003, published in the Official Journal of the European Union (OJEU) L226/21 of 10/09/2003.

³ The *Control Plan* is a confidential part of the ETA and is only handed over to the notified certification body involved in the assessment and verification of constancy of performance.

ANNEX 1: Faveton® SAH kit

Faveton® SAH kit for external wall claddings in ventilated façades are composed of:

1. Cladding elements: three types of extruded ceramic tiles (see table A1.1) according to the harmonized standard EN 14411:

- Faveton® Ceram 28
- Faveton® Ceram 20
- Faveton® Acqua 20-H (horizontal position) & Faveton® Acqua 20-V (vertical position)

2. Cladding fixing: stainless steel clips (see table A1.2).

3. Subframe components:

- vertical profiles (see table A1.3)
- EPDM joint profile (see table A1.4)
- bracket: aluminium alloy supporting and retaining brackets (see table A1.5).
- subframe fixings (see table A1.6).

A1.1 Cladding elements

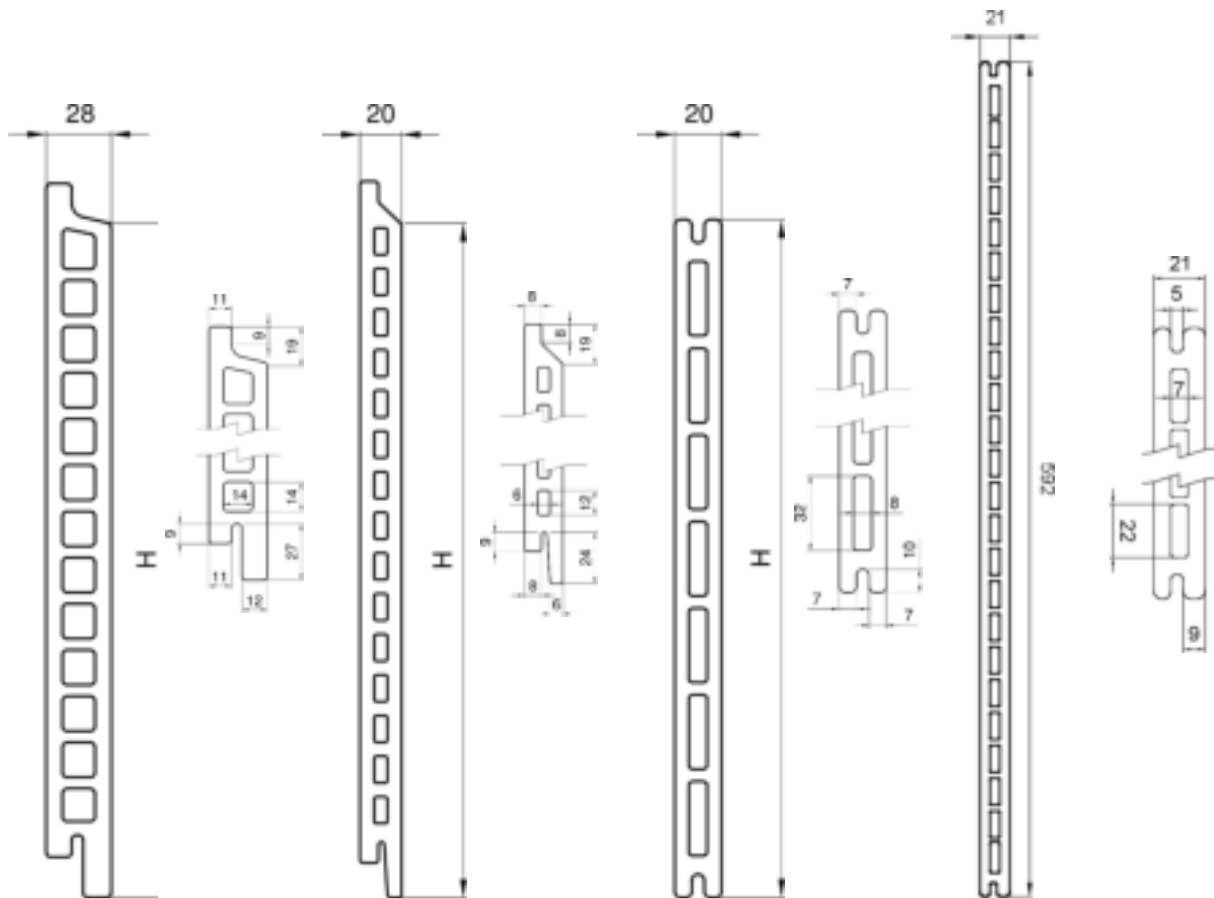

Figure A1.1a: Faveton® Ceram 28.

Figure A1.1b: Faveton® Ceram 20.

Figure A1.1c: Faveton® Acqua 20-H.

Figure A1.1d: Faveton® Acqua 20-V.

Table A1.1: Faveton® SAH cladding elements.

Characteristic		Value				Reference
Trade name		Faveton® Ceram 28	Faveton® Ceram 20	Faveton® Acqua 20-H	Faveton® Acqua 20-V	---
Form	Tile Grooves	Figure A1.1a	Figure A1.1b	Figure A1.1c	Figure A1.1d	---
Manufacturing length, L (mm) (*)		(variable) ± 1 L _{max} ≤ 1500 L _{min} ≥ 500	(variable) ± 1 L _{max} ≤ 1500 L _{min} ≥ 500	(variable) ± 1 L _{max} ≤ 1500 L _{min} ≥ 500	(variable) ± 1 L _{max} ≤ 1500 L _{min} ≥ 500	
(Format): Manufacturing width (mm), H (*)		(200): 190 ± 2 (250): 240 ± 2 (300): 290 ± 2 (400): 390 ± 2 (450): 440 ± 2 (500): 490 ± 2	(200): 190 ± 2 (250): 240 ± 2 (300): 290 ± 2 (400): 390 ± 2 (450): 440 ± 2 (500): 490 ± 2	(200): 192 ± 2 (300): 292 ± 2 (400): 392 ± 2 (500): 492 ± 2 (600): 592 ± 2	(300): 292 ± 2 (400): 392 ± 2 (500): 492 ± 2 (600): 592 ± 2	
Thickness (mm)		28,0 ± 10%	20,0 ± 10%	20,0 ± 10%	20,0 ± 10%	EN ISO 10545-2
Rectangularity		± 1,0%	± 1,0%	± 1,0%	± 1,0%	
Straightness of sides		± 0,3%	± 0,3%	± 0,3%	± 0,3%	
Central curvature						
Lateral curvature		± 0,5%	± 0,5%	± 0,5%	± 0,5%	
Warping						
Surface appearance		> 95% undamaged tiles	> 95% undamaged tiles	> 95% undamaged tiles	> 95% undamaged tiles	
Water absorption (% weight)		3 ≤ Eb ≤ 6	3 ≤ Eb ≤ 6	3 ≤ Eb ≤ 6	3 ≤ Eb ≤ 6	
Apparent relative density (kg/m ³)		2500 ± 200	2500 ± 200	2500 ± 200	2500 ± 200	EN ISO 10545-3
Bulk density (kg/m ³)		2100 ± 200	2100 ± 200	2100 ± 200	2100 ± 200	
Apparent porosity (%)		9,0 ± 1	9,0 ± 1	9,0 ± 1	9,0 ± 1	
Weight per unit (kg)		(variable) ± 10% m _{max} ≤ 53,4	(variable) ± 10% m _{max} ≤ 30,5	(variable) ± 10% m _{max} ≤ 34,3	(variable) ± 10% m _{max} ≤ 34,3	---
Breaking strength (N)		> 800	> 800	> 800	> 800	EN ISO 10545-4
Modulus of rupture (MPa)		> 13	> 13	> 13	> 13	
Resistance to deep abrasion for unglazed tiles (mm ³)		< 541	< 541	< 541	< 541	EN ISO 10545-6
Linear thermal expansion (µm/(m·°C))		≤ 5,1	≤ 5,1	≤ 5,1	≤ 5,1	EN ISO 10545-8
Resistance to thermal shock		Pass	Pass	Pass	Pass	EN ISO 10545-9
Moisture expansion (mm/m)		0,2	0,2	0,2	0,2	EN ISO 10545-10
Crazing resistance for glazed tiles		Pass	Pass	Pass	Pass	EN ISO 10545-11
Frost resistance		No defects	No defects	No defects	No defects	EN ISO 10545-12
Reaction to fire		A1	A1	A1	A1	Decision 96/603/EC with modifications

(*) For the façade design, the dimensions of the joints between the cladding elements should be added.

A1.2 Cladding fixings

Table A1.2: Faveton® SAH clips.

Characteristic	Value				Reference
Geometric properties					
Type of clip	CF-41,5x13x11	CF-41,5x15x11	CF-41,5x13x5	CF-41,5x15x5	---
Form and dimensions	Figure A1.2a	Figure A1.2b	Figure A1.2c	Figure A1.2d	---
Material properties					
Material	Stainless steel 1.4016 (AISI 430)				
Specific weight (kg/m ³)	7900				
Elastic limit (MPa)	≥ 240				
Tensile strength (MPa)	450				
Elongation (%)	> 20				
Modulus of elasticity at 20 °C (kN/mm ²)	220				EN 10088-2
Poisson coefficient	0,32				
Coefficient of thermal expansion between 50 °C and 100 °C (µm/(m·°C))	10,0				

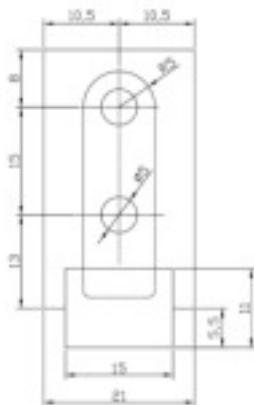

Figure A1.2a: CF-41,5x13x11 clip.

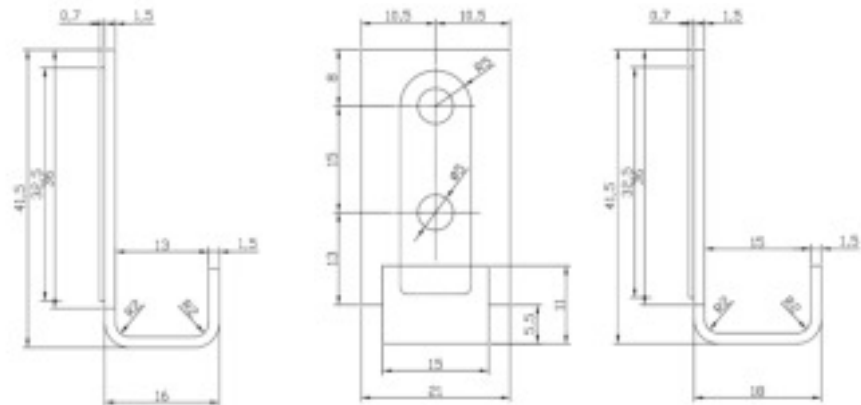

Figure A1.2b: CF-41,5x15x11 clip.

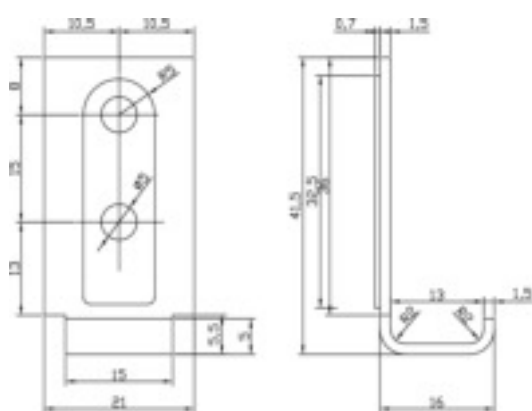

Figure A1.2a: CF-41,5x13x5 clip.

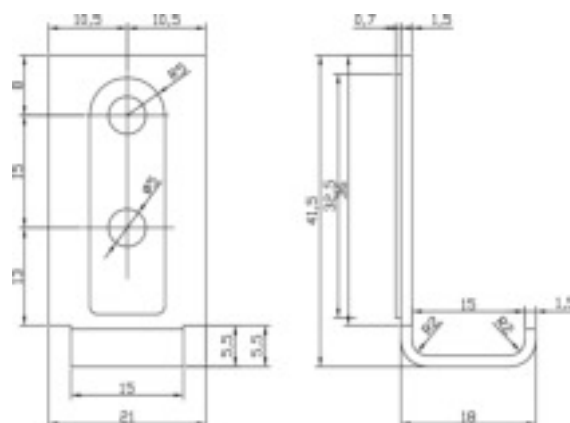

Figure A1.2b: CF-41,5x15x5 clip.

A1.3 Subframe

Table A1.3: Faveton® SAH vertical profiles.

Characteristic	Value		Reference
Geometric properties			
Type of profile	PFC	PFH	---
Form	Figure A1.3a	Figure A1.3b	---
Weight per linear metre (g/m)	981	727	
Cross section (mm ²)	363	269	
Standard length (m)	6,0	6,0	---
Inertia of profile section I _{xx} (cm ⁴)	12,61	11,11	
Inertia of profile section I _{yy} (cm ⁴)	13,81	4,95	
Material properties			
Material	EN AW-6063		
Treatment	T5		
Durability class	B		
Specific weight (kg/m ³)	2700		
Elastic limit (MPa)	130		EN 755
Tensile strength (MPa)	175		EN 1999-1
Modulus of elasticity (MPa)	70000		
Poisson coefficient	0,34		
Coefficient of thermal expansion between 50 °C and 100 °C (µm/(m·°C))	23,5		

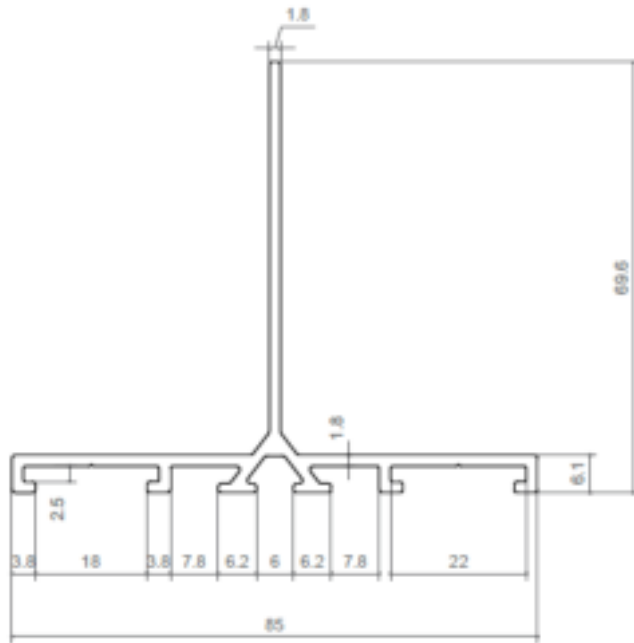

Figure A1.3a: PFC profile.

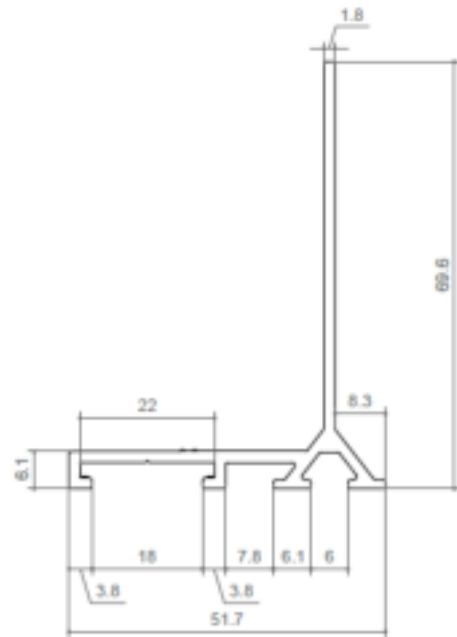

Figure A1.3b: PFH profile.

Table A1.4: Faveton® SAH EPDM profile.

Characteristic	Value	Reference
Material	EPDM profile	
Form	Figure A1.4	
Cross section (mm ²)	105	---
Weight per linear metre (g/m)	0,145	
Density (kg/m ³)	1290 - 1350	ISO 2781
Tensile strength (MPa)	≥ 7	ISO 37
Elongation at break (%) (*)	≥ 150	
Hardness, 3 sec (ShA)	70 - 75	ISO 7619-1

(*) Due to ageing, elongation at break can reach a value of 150%.

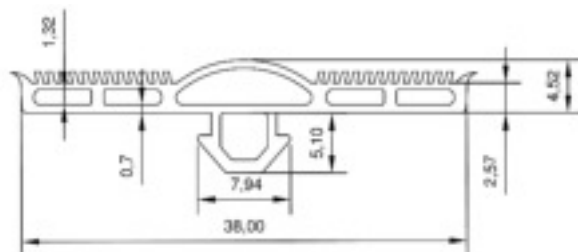

Figure A1.4: EPDM joint profile.

Table A1.5: Faveton® SAH brackets geometric and material properties.

Geometric properties						
Type of bracket (*)		Form and dimensions		Mass per unit (g)		
Height 120	CAA_ 120 x L x 60 x 3,0	L = 60 (r)	Figure A1.5a	from 113 to 191		
		L = 90 (r)				
		L = 100				
		L = 120				
		L = 140				
Height 120	CAA_ 120 x L x 60 x 4,0	L = 90 (r)	Figure A1.5b	189		
Height 60	CAA_ 60 x L x 60 x 3,0	L = 60	Figure A1.5c	from 56 to 95		
		L = 90				
		L = 100				
		L = 120				
		L = 140				
Height 60	CAA_ 60 x L x 60 x 4,0	L = 90	Figure A1.5d	94		
Material properties						
Characteristic		Value	Reference			
Material (**)		EN AW-6060	EN 755 EN 1999-1			
Treatment		T5				
Durability class		B				
Specific weight (kg/m ³)		2700				
Elastic limit (MPa)		≥ 120				
Elongation (%)		≥ 6				
Tensile strength (MPa)		≥ 160				
Modulus of elasticity longitudinal (MPa)		59300				
Modulus of elasticity transversal (MPa)		27000				
Poisson coefficient		0,30				
Coefficient of thermal expansion between 50 °C and 100 °C (µm/(m.°C))		23,2				
(*) H x L x B x t where: H = height, L = length; B = base; t = thickness						
(**) Other aluminium alloys according to EN 755-2 with better material mechanical properties than AW 6063 T5 may be used.						
(r) The bracket marked with (r) may be opposite positioned, i.e. the base is the wing.						

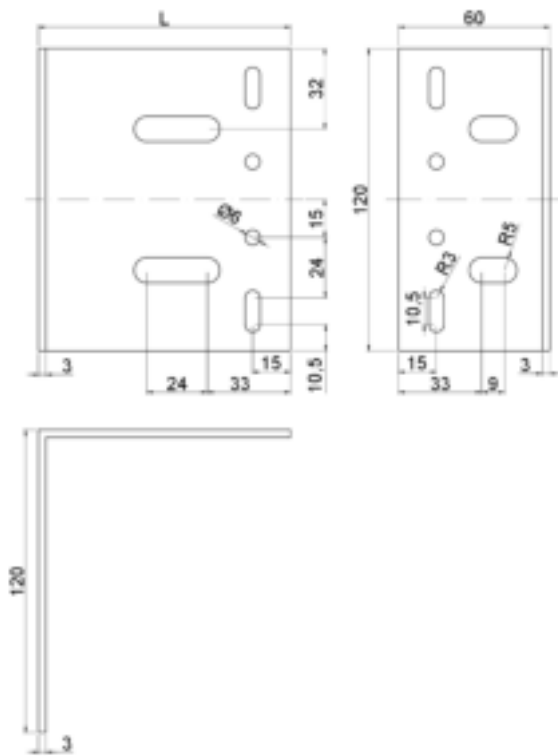

Figure 2.4a: CAA_120 x L x 60 x 3,0.

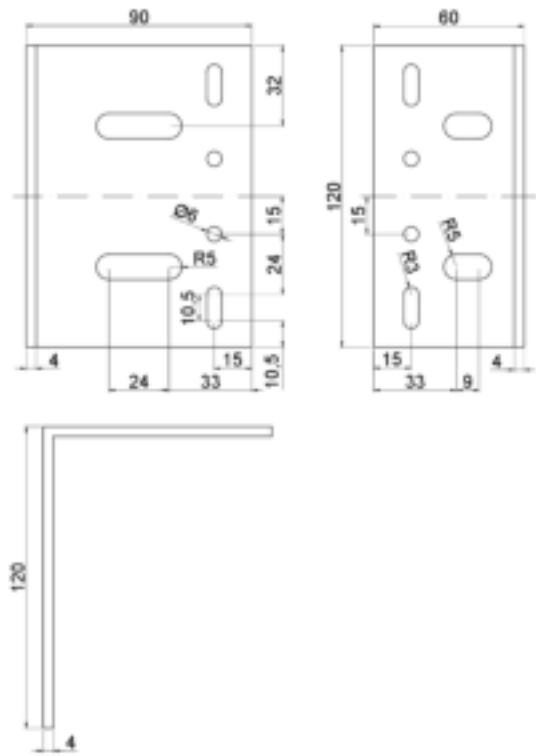

Figure 2.4b: CAA_120 x 90 x 60 x 4,0.

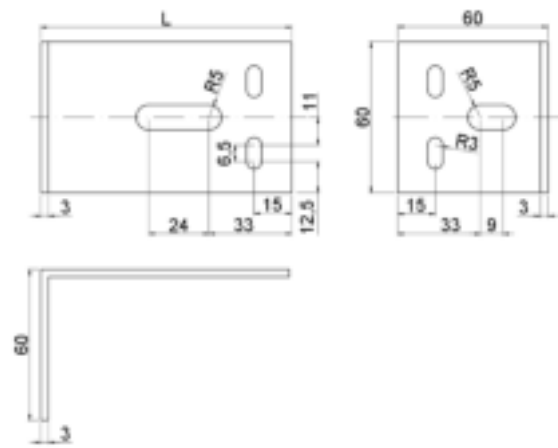

Figure 2.4c: CAA_60 x L x 60 x 3,0.

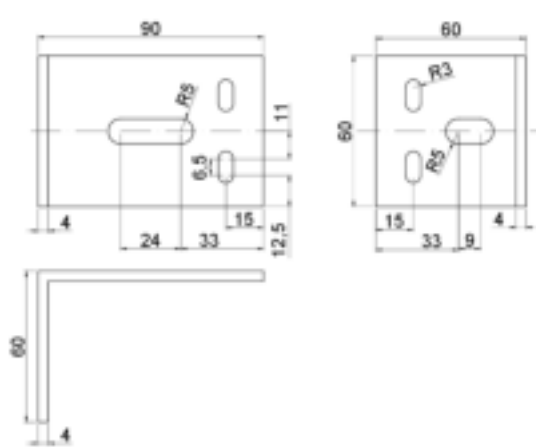

Figure 2.4d: CAA_60 x 90 x 60 x 4,0.

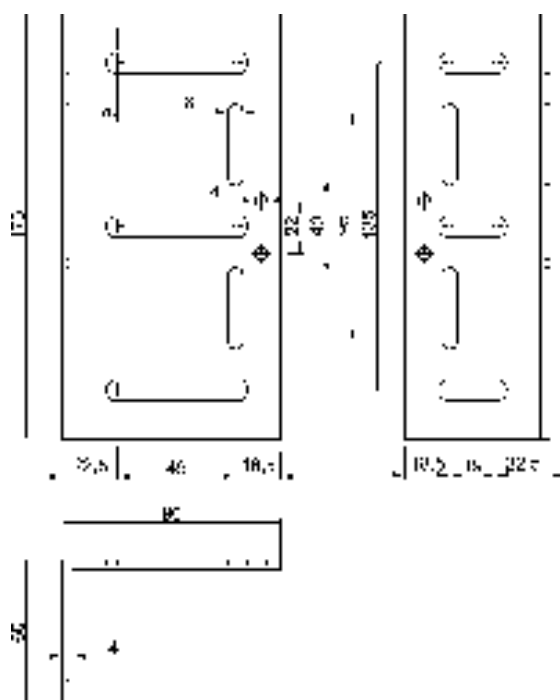

Figure 2.4e: 175 x 90 x 60 x 4,0.

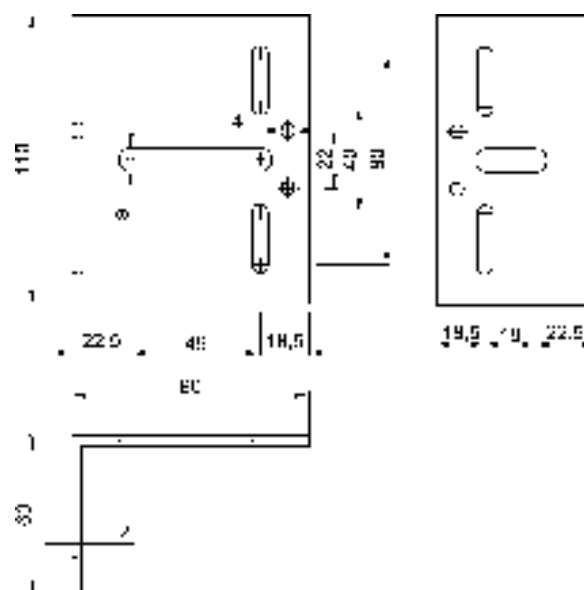

Figure 2.4f: 110 x 90 x 60 x 4,0.

Table A1.6: Faveton® SAH subframe fixings.

Fixing elements	Geometry		Material		Reference
Position	Type	Description	Type	Class	---
Between the cladding fixing (clip) and the vertical profiles	Self-drilling screws	ST 5,5 x L (L ≥ 19 mm)	Stainless steel	A2-70	EN ISO 3506-4 EN ISO 15480 EN ISO 10666
	Fasteners	5 x 20			EN ISO 3506-1 EN ISO 3506-3
Between the vertical profile and the brackets	Self-drilling screws	ST 5,5 x L (L ≥ 35 mm)	Stainless steel	A2-70	EN ISO 3506-4 EN ISO 15480 EN ISO 10666
	Screws	M8 (8x25)	Stainless steel	A2-70	EN ISO 3506-1 EN ISO 4017
	Locknuts	M8	Stainless steel	A2-70	EN ISO 3506-2 EN ISO 10511
	Broad wing washers	M8	Stainless steel	A2-70	EN ISO 887 EN ISO 7093 EN ISO 10673
	Washers	6,8x16	Polychloroprene (neoprene)	A2-70	ISO 3934

ANNEX 2: Construction details

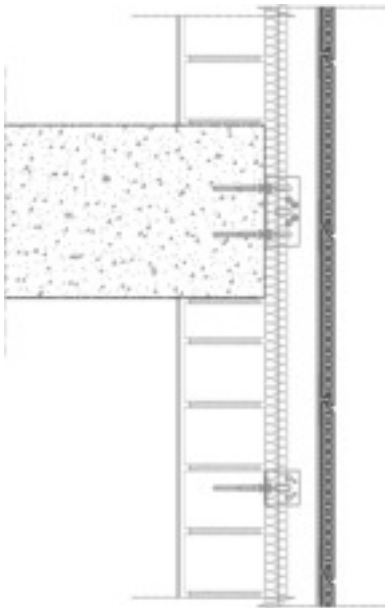

Figure A2.1a: Vertical section. Faveton® SAH Ceram 20.

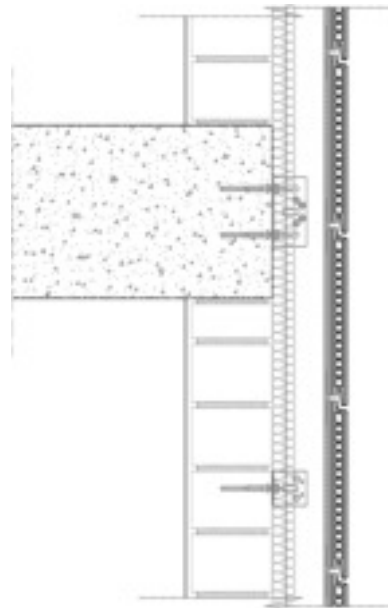

Figure A2.1b: Vertical section. Faveton® SAH Ceram 28.

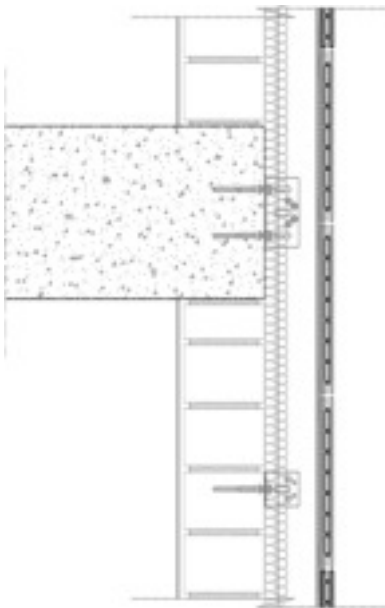

Figure A2.1c: Vertical section. Faveton® SAH Acqua 20-H.

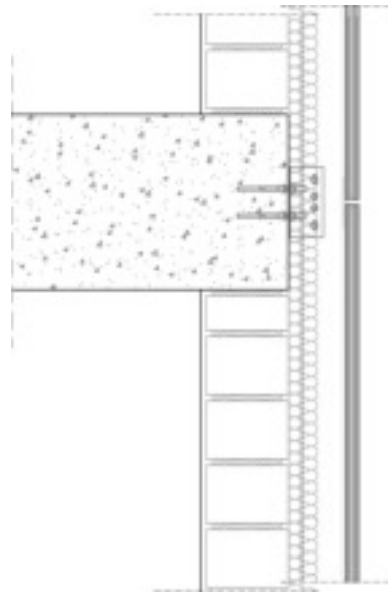

Figure A2.1d: Vertical section. Faveton® SAH Acqua 20-V.

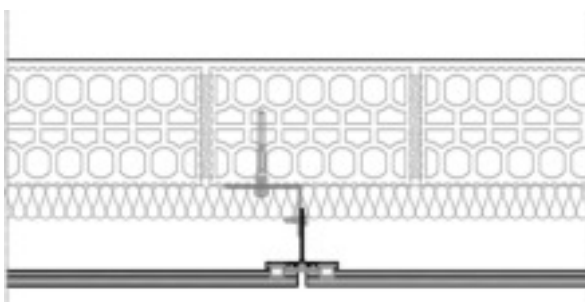

Figure A2.2a: Horizontal section. Faveton® SAH Ceram 20.

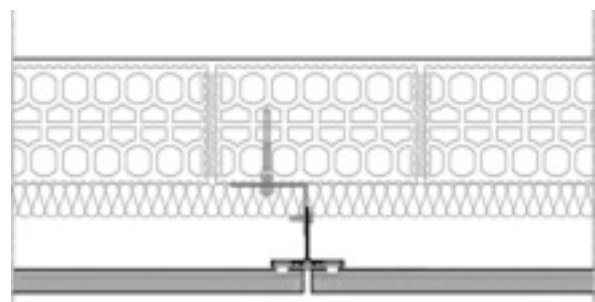

Figure A2.2b: Horizontal section. Faveton® SAH Ceram 28.

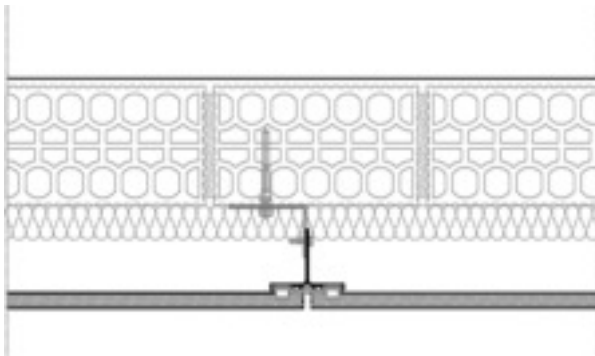

Figure A2.2c: Horizontal section. Faveton® SAH Acqua 20-H.

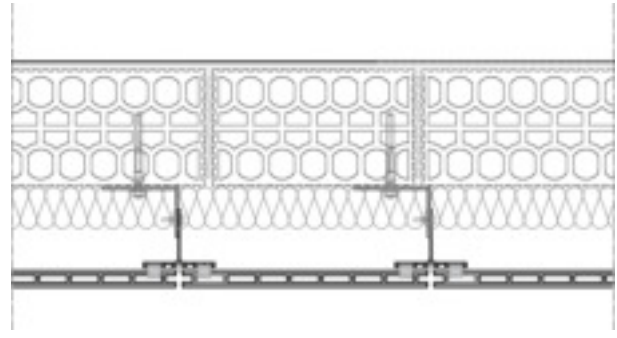

Figure A2.2d: Horizontal section. Faveton® SAH Acqua 20-V.

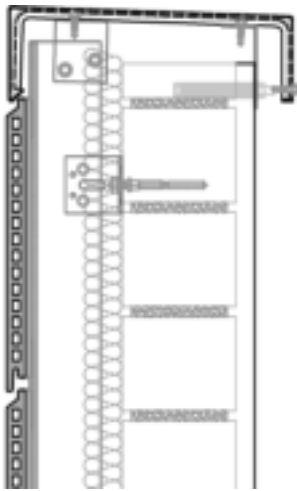

Figure A2.3a: Roof edge with metal piece.

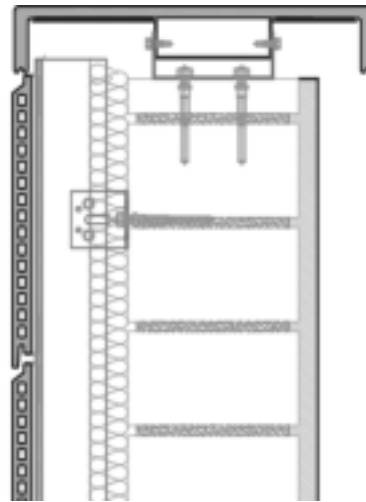

Figure A2.3b: Roof edge with ceramic piece.

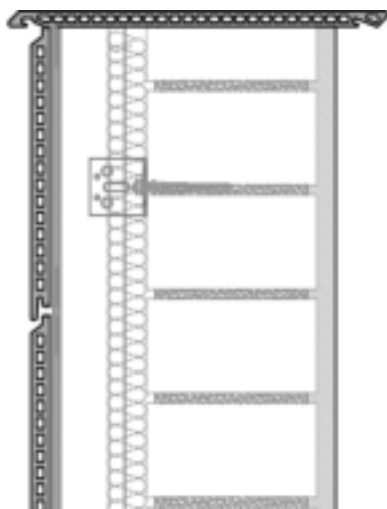

Figure A2.3c: Roof edge with Faveton® piece.

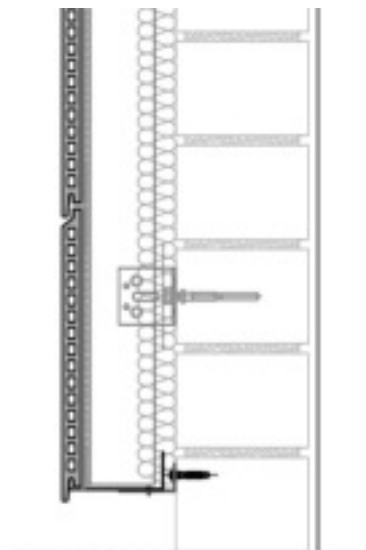

Figure A2.4: Base edge with metal piece.

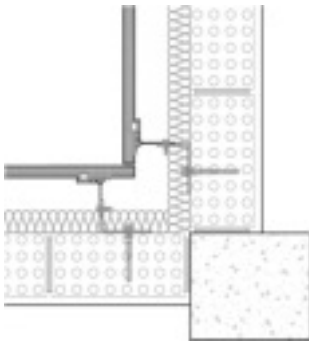

Figure A2.5a: Internal corner.

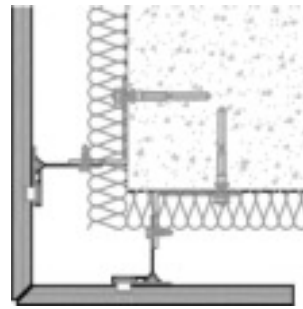

Figure A2.5b: External corner. L-vertical profile.

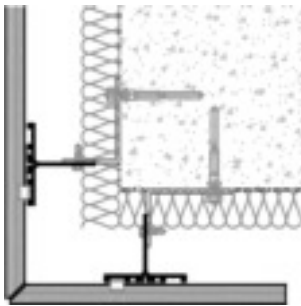

Figure A2.5c: External corner. T-vertical profile.

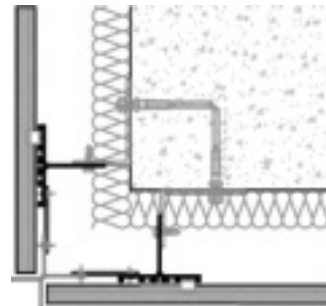

Figure A2.5d: External corner, ancillary corner profile.

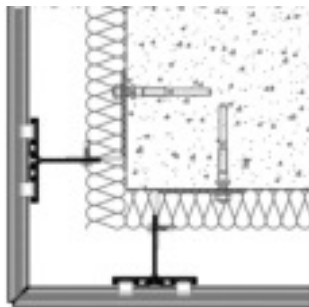

Figure A2.5e: External corner. T-vertical profile (vertical insertion of the piece).

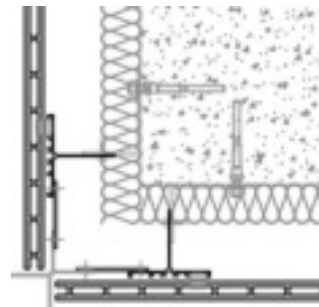

Figure A2.5f: External corner, ancillary corner profile (vertical insertion of the piece).

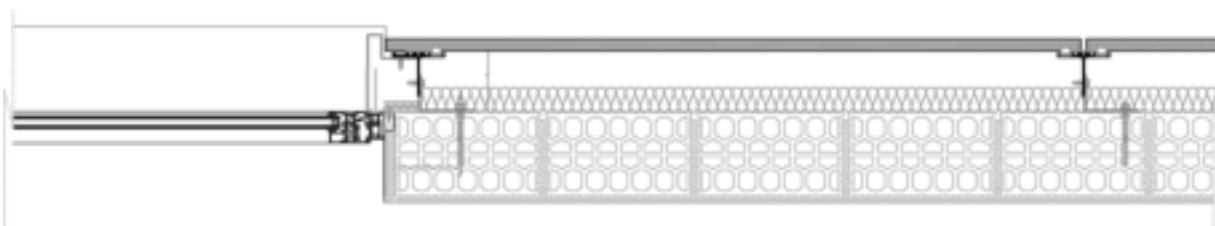

Figure A2.6a: Jamb with metal piece.

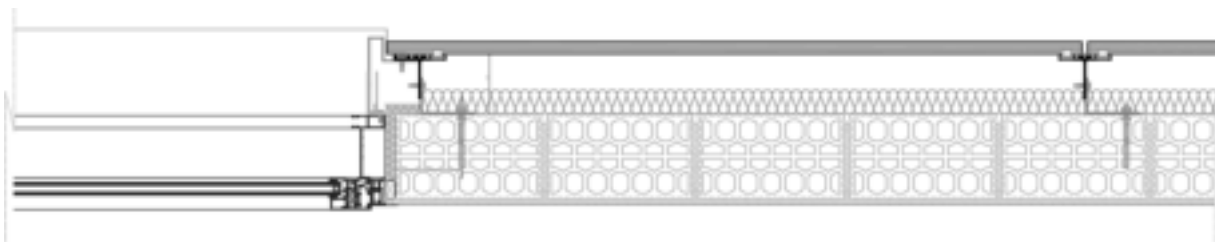

Figure A2.6b: Jamb with metal piece and blind.

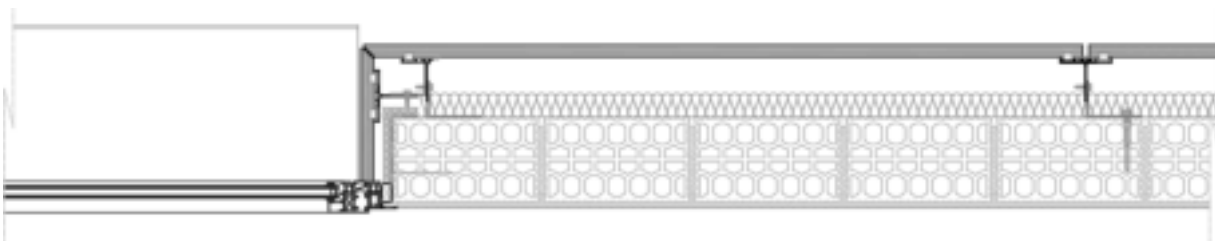

Figure A2.6c: Jamb with ceramic piece.

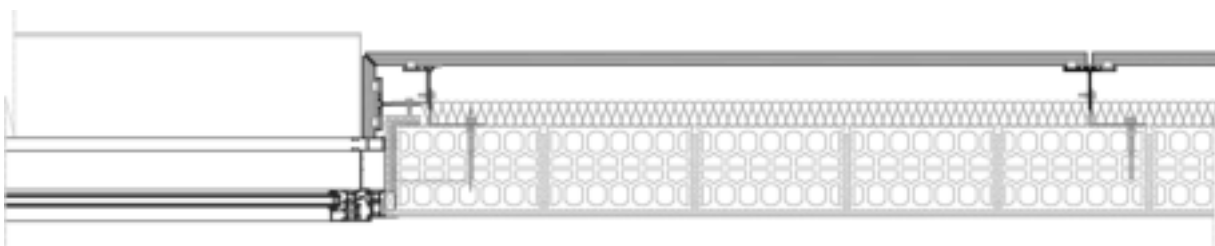

Figure A2.6d: Jamb with ceramic piece and blind.

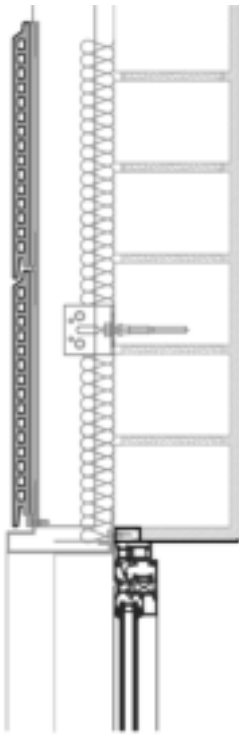

Figure A2.7a: Lintel with metal piece.

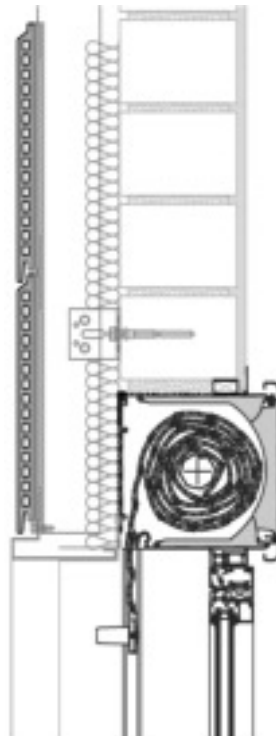

Figure A2.7b: Lintel with metal piece and blind.

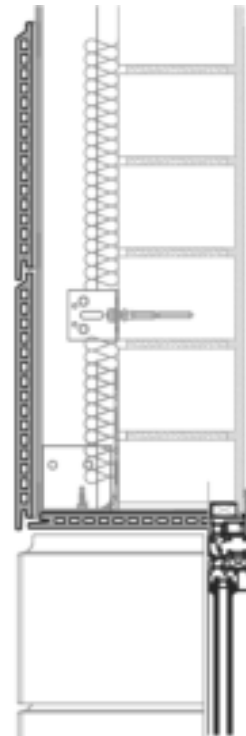

Figure A2.7c: Lintel with ceramic piece.

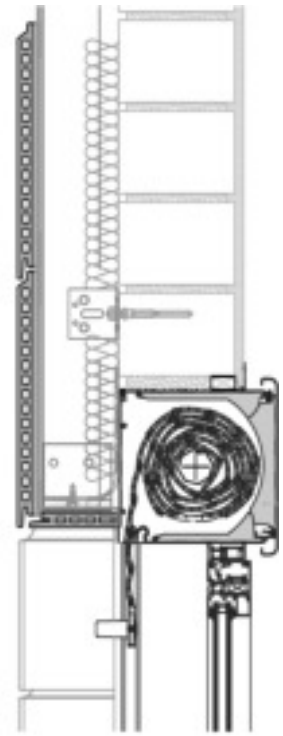

Figure A2.7d: Lintel with ceramic piece and blind.

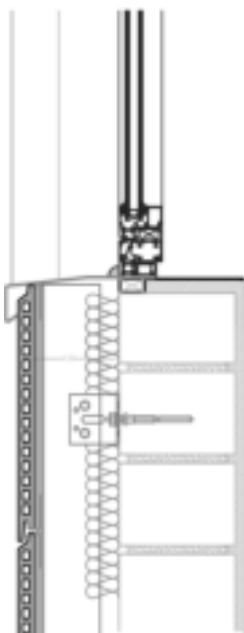

Figure A2.8a: Sill with metal piece.

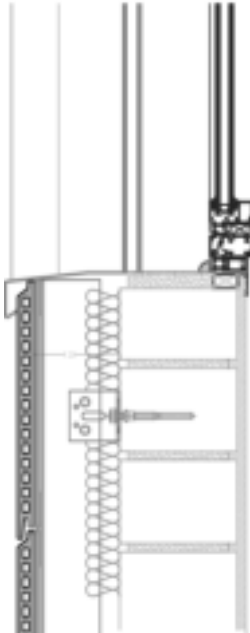

Figure A2.8b: Sill with metal piece and blind.

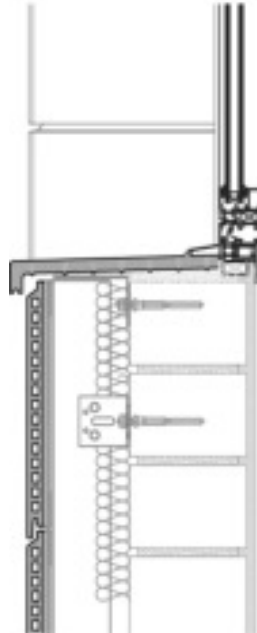

Figure A2.8c: Sill with ceramic piece.

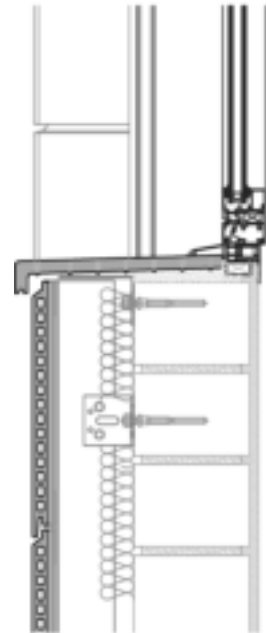

Figure A2.8d: Sill with ceramic piece and blind.

ANNEX 3: Design, installation, maintenance and repair criteria

A3.1 Design

The design of the external wall claddings for ventilated façades using Faveton® SAH kit should consider:

- It is assumed that the substrate wall meets the necessary requirements regarding the mechanical strength (resistance to static and dynamic loads) and the airtightness, as well as the relevant resistance regarding watertightness and water vapour.
- The verification of the designed system by means of calculation, taking into account the mechanical characteristic values of the kit components in order to resist the actions (dead loads, wind loads, etc.) applying on the specific works. National safety factors and other national provisions must be followed.
- The selection and verification of the brackets which support the subframe vertical profiles considering compatible materials (e.g. aluminium alloy) and the mechanical resistance (vertical and horizontal resistance) according to the envisaged actions obtained from the mechanical calculation of the designed system.
- The selection and verification of the anchors between the brackets and the external walls (substrate), taking into account the substrate material and the minimum resistance required (pull-out and shear resistance) according to the envisaged actions obtained from the mechanical calculation of the designed system.
- The accommodation of the designed system movements to the substrate or structural movements.
- The execution of singular parts of the façade; some examples of construction details are indicated in Annex 2.
- The corrosion protection of the designed system metallic components taking into account the category of corrosivity of the atmosphere of works (e.g. acc. ISO 9223).
- The drainability of the ventilated air space between the cladding elements and the insulation layer or the external wall accordingly.
- An insulation layer is usually fixed on the external wall and should be defined in accordance with a harmonized standard or a European technical assessment and taking into account the section 3.1 of this ETA.
- Because the joints are not watertight, the first layer behind ventilated air space (e.g. insulation layer) should be composed by materials with low water absorption.

A3.2 Installation

Installation of the external wall claddings for ventilated façades using Faveton® SAH kit should be carried out:

- According to the specifications of the manufacturer and using the components specified in this ETA.
- In accordance with the design and drawings prepared for the specific works. The manufacturer should ensure that the information on these provisions is given to those concerned.
- By appropriately qualified staff and under the supervision of the technical responsible of the specific works.

A3.3 Maintenance and repair

Maintenance of the external wall claddings for ventilated façades using Faveton® SAH kit includes inspections on site, taking into account the following aspects:

- Regarding the cladding elements: the appearance of any damage such as cracking, detachment, delamination, and mould presence due to permanent moisture or permanent irreversible deformation.
- Regarding metallic components: the presence of corrosion or presence of water accumulation.

When necessary, any repair to localized damaged areas must be carried out with the same components and following the repair instructions given by the manufacturer.